



Stoginiai ventilatoriai

Roof fans

Dachventilatoren

Крышные вентиляторы



Stoginiai ventilatoriai, skirti oro ištraukimui. Nenaudojami užteršto oro, agresyvių, sprogių dujų transportavimui.

Sparnuotė: atgal lenktais sparneliais, plastmasinė/cinkuoto plieno.

Variklis: išorinis rotorius, integruota termokontaktinė variklio apsauga, ilgai tarnaujantys nereikalaujantys priežiūros guoliai.

Korpusas: dažytas RAL 7035.



Dachventilatoren, für Abluft bestimmt. Nicht geeignet für die Beförderung von verschmutzter Luft, aggressiven, explosiven Gasen.

Laufblad ist rückwärts gekrümmt, aus Kunststoff oder verzinktem Stahl.

Der Motor: Außenrotor, integrierter Thermokontakt-Motorschutz, dauerhafte, keine Pflege erfordernde Lager.

Das Gehäuse: RAL 7035, gestrichen.



Roof fans with horizontal discharge are used to extract air from different premises. Easy access to clean an impeller. Not suitable for polluted air, aggressive and explosive gases.

Impeller with backward curved blades made of galvanized steel.

Motor: external rotor, motor protection built-in thermal-contact, free-maintenance ball bearings.

Housing: powder coated painting RAL 7035.



Крышные вентиляторы для вытяжки воздуха. Не используются при транспортировке загрязнённого воздуха, агрессивных, взрывоопасных газов.

Крыльчатка: загнутые назад лопатки, пластмасса/оцинкованная сталь.

Двигатель: наружный ротор, встроенная термодатная защита двигателя, не требующие ухода подшипники с длительным сроком службы.

Корпус: окрашенный RAL 7035.

Accessories



KSV
p. 179



TGRV
p. 143



MTY
p. 146

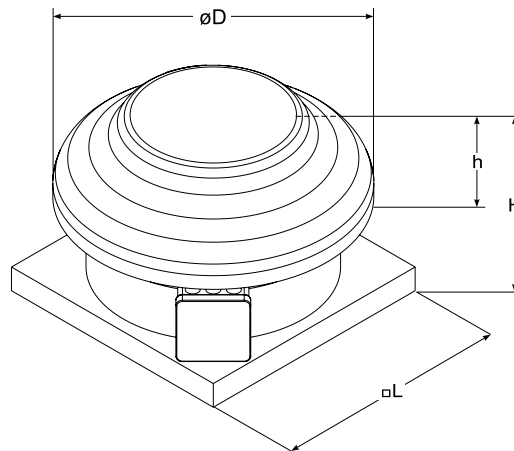

Type	Dimensions [mm]			
	$\varnothing D$	H	h	$\square L$
VSA 175 M	344	227	107	305
VSA 190 L	344	227	107	305
VSA 220 S	450	234	109	405
VSA 220 M	450	234	109	405
VSA 225 L	450	247	109	405
VSA 250 L	450	247	109	405

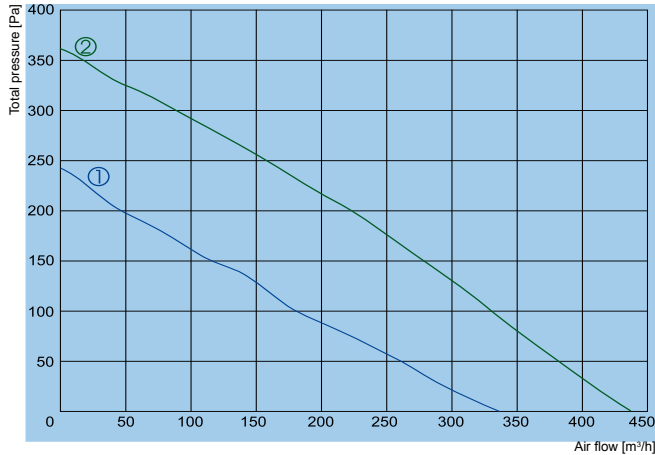

① VSA 175 M
② VSA 190 L

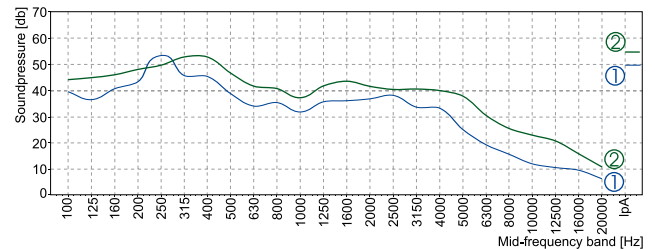

		VSA 175 M	VSA 190 L
Voltage/Frequency	[V/Hz]	230/50	230/50
Power consumption	[kW]	0,053	0,058
Current	[A]	0,33	0,26
Speed	[min ⁻¹]	2350	2500
Max. airflow	[m ³ /h]	336	437
Max. air temperature	[°C]	40	50
Total sound pressure level at 10 m	[dBA]	19	24
Speed controller		TGRV1,5 / MTY0	TGRV1,5 / MTY0
Weight	[kg]	4,0	4,4
Wiring diagram		No. 1	No. 1
Protection class:	motor	IP-44	IP-44
	terminal box	IP-54	IP-54

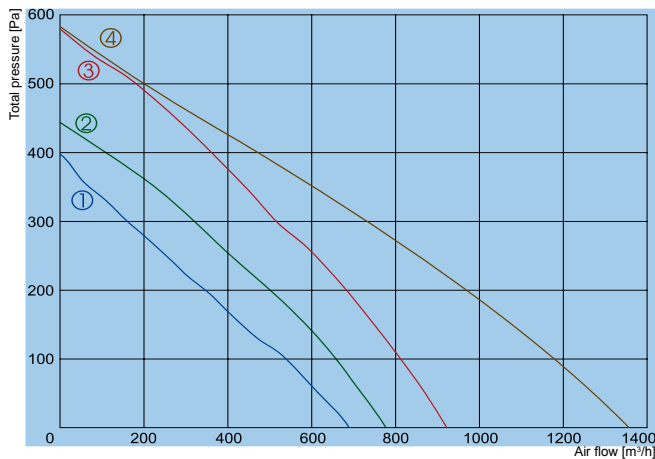

① VSA 220 S
② VSA 220 M
③ VSA 225 L
④ VSA 250 L

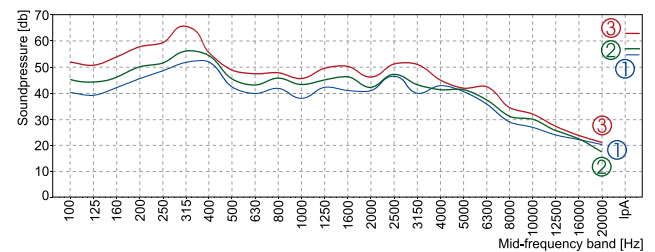

		VSA 220 S	VSA 220 M	VSA 225 L	VSA 250 L
Voltage/Frequency	[V/Hz]	230/50	230/50	230/50	230/50
Power consumption	[kW]	0,085	0,085	0,135	0,16
Current	[A]	0,38	0,38	0,60	0,71
Speed	[min ⁻¹]	2600	2700	2650	2650
Max. airflow	[m ³ /h]	689	770	922	1357
Max. air temperature	[°C]	40	55	60	40
Total sound pressure level at 10 m	[dBA]	24	26	32	38
Speed controller		TGRV1,5 / MTY 0	TGRV1,5 / MTY 0	TGRV1,5/MTY1	TGRV1,5/MTY1
Weight	[kg]	6,6	7,0	7,8	7,9
Wiring diagram		No. 1	No. 1	No. 1	No. 1
Protection class:	motor	IP-44	IP-44	IP-44	IP-44
	terminal box	IP-54	IP-54	IP-54	IP-54

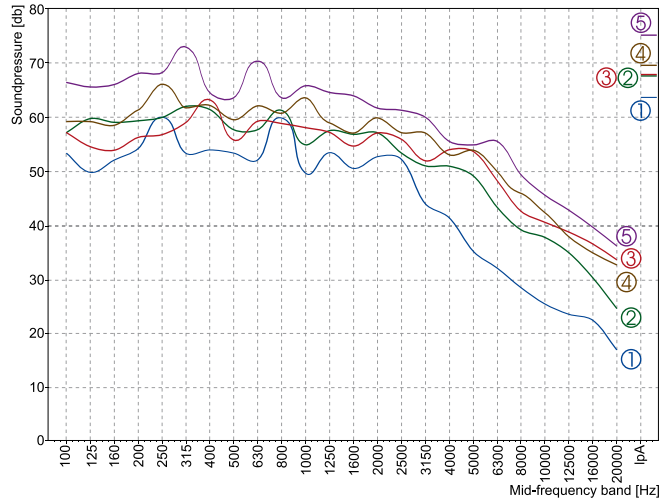

Sound diagram No. 3

Measured with 5 microphones at 1,3 m radius

- ① VSA 175 M
- ② VSA 190 L
- ③ VSA 220 S
- ④ VSA 220 M
- ⑤ VSA 225 L

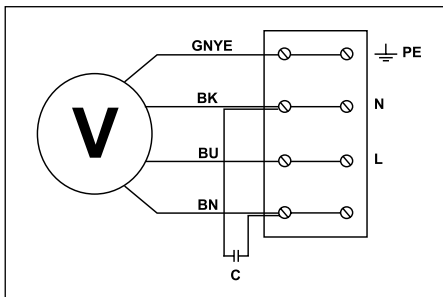

Wiring diagram No. 1 (1~230V)

- GNYE - green-yellow / grün-gelb
- BK - black / schwarz
- BU - blue / blau
- BN - brown / braun